

EN

**OPERATING MANUAL
CONVECTOR**



EN This product is only suitable for well insulated spaces or occasional use.

Table of contents

Notes regarding the operating manual..... 2

Safety 2

Information about the device..... 5

Transport and storage..... 6

Assembly and start-up 6

Operation 8

Errors and faults 9

Maintenance 10

Technical annex..... 10

Disposal 12

Notes regarding the operating manual

Symbols

 **Warning of electrical voltage**
This symbol indicates dangers to the life and health of persons due to electrical voltage.

 **Warning of hot surface**
This symbol indicates dangers to the life and health of persons due to hot surface.

 **Warning**
This signal word indicates a hazard with an average risk level which, if not avoided, can result in serious injury or death.

 **Caution**
This signal word indicates a hazard with a low risk level which, if not avoided, can result in minor or moderate injury.

Note
This signal word indicates important information (e.g. material damage), but does not indicate hazards.

 **Info**
Information marked with this symbol helps you to carry out your tasks quickly and safely.

 **Follow the manual**
Information marked with this symbol indicates that the operating manual must be observed.

You can download the current version of the operating manual and the EU declaration of conformity via the following link:

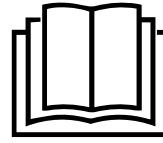

TCH 2050 E





<https://hub.trotec.com/?id=43768>

Safety

Read this manual carefully before starting or using the device. Always store the manual in the immediate vicinity of the device or its site of use.

 **Warning**
Read all safety warnings and all instructions. Failure to follow the warnings and instructions may result in electric shock, fire and/or serious injury. **Save all warnings and instructions for future reference.**
This appliance can be used by children aged from 8 years and above and persons with reduced physical, sensory or mental capabilities or lack of experience and knowledge if they have been given supervision or instruction concerning use of the appliance in a safe way and understand the hazards involved. Children shall not play with the appliance. Cleaning and user maintenance shall not be made by children without supervision.

 **Warning**
Children of less than 3 years should be kept away from the device unless continuously supervised. Children aged from 3 years and less than 8 years shall only switch on/off the appliance provided that it has been placed or installed in its intended normal operating position and they have been given supervision or instruction concerning use of the appliance in a safe way and understand the hazards involved. Children aged from 3 years and less than 8 years shall not plug in, regulate and clean the appliance or perform user maintenance.

 **Warning**
Do not use the device in small rooms if persons are present who cannot leave the room independently and who are not under constant supervision.

- Do not use the device in potentially explosive rooms or areas and do not install it there.
- Do not use the device in aggressive atmosphere.

- Only put up the device in an upright, stable position on firm ground.
- Let the device dry out after a wet clean. Do not operate it when wet.
- Do not use the device with wet or damp hands.
- Do not expose the device to directly squirting water.
- Never insert any objects or limbs into the device.
- Do not cover the device during operation.
- Do not remove any safety signs, stickers or labels from the device. Keep all safety signs, stickers and labels in legible condition.
- Do not sit on the device.
- This appliance is not a toy. Keep away from children and animals. Do not leave the device unattended during operation.
- Check accessories and connection parts for possible damage prior to every use of the device. Do not use any defective devices or device parts.
- Ensure that all electric cables outside of the device are protected from damage (e.g. caused by animals). Never use the device if electric cables or the power connection are damaged!
- The mains connection must correspond to the specifications in the Technical annex.
- Insert the mains plug into a properly fused mains socket.
- Observe the device's power input, cable length and intended use when selecting extensions to the power cable. Completely unroll extension cables. Avoid electrical overload.
- Before carrying out maintenance, care or repair work on the device, remove the mains plug from the mains socket. Hold onto the mains plug while doing so.
- Switch the device off and disconnect the power cable from the mains socket when the device is not in use.
- Do not under any circumstances use the device if you detect damages on the mains plug or power cable. If the power cable is damaged, it must be replaced by the manufacturer, its service agent or similarly qualified persons in order to avoid a hazard. Defective power cables pose a serious health risk!
- When installing the device, observe the minimum distances from walls and other objects as well as the storage and operating conditions according to the technical data (chapter Technical annex).
- Keep a safety distance of at least 1 m between the air inlet and the air outlet of the device and all combustible materials such as textiles, curtains, beds and sofas.
- Make sure that the air inlet and outlet are not obstructed.
- Make sure that the suction side is kept free of dirt and loose objects.
- Do not place the device on combustible ground.
- Only use original spare parts, for otherwise safe and functional operation cannot be ensured.
- Allow the device to cool down before transport and/or maintenance work.
- The device must not be positioned directly beneath a wall socket.
- Do not use the device if it has been dropped or if it shows visible signs of damage.
- Do not insert rechargeable batteries into the remote control.
- Use the CR 2025 button battery type.
- Never charge batteries that cannot be recharged.
- Different types of batteries and new and used batteries must not be used together.
- Insert the batteries into the battery compartment according to the correct polarity.
- Remove discharged batteries from the device. Batteries contain materials hazardous to the environment. Dispose of the batteries according to the national regulations.
- Remove the batteries from the remote control if you will not be using the device for a longer period of time.
- Never short-circuit the supply terminal in the battery compartment!
- Do not swallow batteries! If a battery is swallowed, it can cause severe internal burns within 2 hours! These burns can lead to death!
- If you think batteries might have been swallowed or otherwise entered the body, seek medical attention immediately!
- Keep new and used batteries and an open battery compartment away from children.
- If the battery compartment does not close securely, stop using the product via the remote control.

Intended use

The device is only suitable for well insulated spaces or occasional use.

Only use the device for heating closed rooms whilst adhering to the technical data.

Intended use comprises heating the air in:

- living spaces
- storerooms
- salesrooms
- construction areas
- containers
- basements

Foreseeable misuse

- Do not place the device on wet or flooded ground.
- Do not place any objects, e.g. clothing, on the device.
- Do not use this device in the vicinity of fuel, solvents, varnishes or other easily inflammable vapours or in rooms where these substances are stored.
- Do not use the device out of doors.
- Do not use the device for heating vehicles.
- This heating device must not be used in wet rooms.
- Never immerse the device in water.
- Never heat rooms with a cubature of less than 4 m³. Risk of overheating!
- Any use other than the intended use is regarded as a reasonably foreseeable misuse.
- Do not make any unauthorised modifications, alterations or structural changes to the device.

Personnel qualifications

People who use this device must:

- be aware of the dangers that occur when working with electric devices in damp areas.
- have read and understood the operating manual, especially the Safety chapter.

Maintenance tasks which require the housing to be opened must only be carried out by specialist electrical companies or by Trotec.

Symbols on the device

| Symbols | Meaning |
|--|--|
|  | This symbol located on the device indicates that it is prohibited to place objects (such as towels, clothes etc.) above or directly in front of the device. In order to avoid overheating and fire hazards, the heater must not be covered. |

Residual risks



Warning of electrical voltage

Work on the electrical components must only be carried out by an authorised specialist company!



Warning of electrical voltage

Before any work on the device, remove the mains plug from the mains socket!
Do not touch the mains plug with wet or damp hands. Hold onto the mains plug while pulling the power cable out of the mains socket.



Warning of electrical voltage

Risk of electric shock!
The device must not come into contact with water, otherwise there is a risk of an electric shock!
Do not use this heating device in wet rooms!



Warning of hot surface

Parts of this appliance can become very hot and cause burns. Particular attention is to be paid when there are children or vulnerable persons present!



Warning

Improper handling entails a risk of burning and electric shock.
Only use the device as intended!



Warning

Dangers can occur at the device when it is used by untrained people in an unprofessional or improper way!
Observe the personnel qualifications!



Warning

The device is not a toy and does not belong in the hands of children.



Warning

Risk of suffocation!
Do not leave the packaging lying around. Children may use it as a dangerous toy.



Warning

Improper installation entails a risk of fire.
Do not place the device on combustible ground.
Do not place the device on high-pile carpets.
Do not use the device without the feet attached.



Warning

In order to avoid overheating and fire hazards, the device must not be covered!

Behaviour in the event of an emergency

1. Switch the device off.
2. In an emergency, disconnect the device from the mains feed-in: Hold onto the mains plug while pulling the power cable out of the mains socket.
3. Do not reconnect a defective device to the mains.

Overheating protection

The device is provided with a safety thermostat which is activated by overheating of the device (when exceeding the operating temperature).

Once the safety thermostat has switched itself on, the device will be turned off.

When the device has cooled down sufficiently, the heating will be switched back on.

Investigate the cause of overheating.

If the safety thermostat does not switch in the event of overheating, the overheating protection will be tripped. In that case the device switches off completely. If so, please contact the customer service to have the overheating protection replaced.

Information about the device

Device description

The device is used to generate warm air for interior spaces.

The device generates heat by means of an electric heating element. The air surrounding the heating element is heated. The heated air moves through the air outlet towards the top and sides and so enters the room.

The device is equipped with an integrated temperature sensor which controls the heating level depending on the current and the desired room temperature.

Via the control panel you can set a target temperature value between 15 °C and 35 °C.

Operation of the device is possible either via the control panel at the device or via the supplied infrared remote control.

The feet's integrated castors allow for a convenient positioning of the device inside the room.

Device depiction

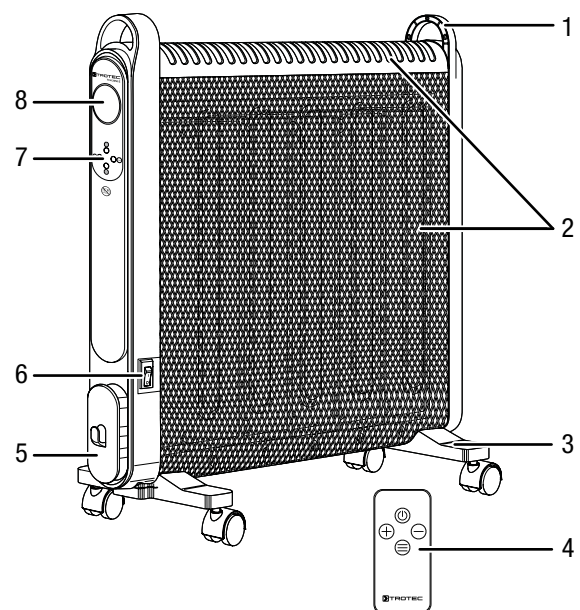

| No. | Designation |
|-----|--------------------|
| 1 | Handle |
| 2 | Air outlet |
| 3 | Foot with wheels |
| 4 | Remote control |
| 5 | Power cable holder |
| 6 | On/off switch |
| 7 | Control panel |
| 8 | Display |

Transport and storage

Note

If you store or transport the device improperly, the device may be damaged.

Note the information regarding transport and storage of the device.

Transport

To make the device easier to transport, it is fitted with wheels.

To make the device easier to transport, it is fitted with a carry handle.

Before transporting the device, observe the following:

- Switch the device off.
- Hold onto the mains plug while pulling the power cable out of the mains socket.
- Do not use the power cable to drag the device.
- Allow the device to cool down sufficiently.

Storage

Before storing the device, proceed as follows:

- Hold onto the mains plug while pulling the power cable out of the mains socket.
- Allow the device to cool down sufficiently.

When the device is not being used, observe the following storage conditions:

- Store the device in a dry location and protected from frost and heat.
- Store the device in an upright position where it is protected from dust and direct sunlight.
- If required, use a cover to protect the device from invasive dust.
- Place no further devices or objects on top of the device to prevent it from being damaged.
- Remove batteries from the remote control.

Assembly and start-up

Scope of delivery

- 1 x Convector
- 1 x Remote control
- 2 x Foot
- 6 x Screw (for foot)
- 1 x Manual

Unpacking the device

1. Open the cardboard box and take the device out.
2. Completely remove the packaging.
3. Fully unwind the power cable. Make sure that the power cable is not damaged and that you do not damage it during unwinding.

Assembly



Warning

Risk of fire due to improper installation!

There is a risk of fire if the required minimum distances are not observed.

Observe the "Installation" section in the "Assembly and start-up" chapter and the technical data in the "Technical annex" chapter.

Assembly of feet with castors

1. Place the device on its side.
2. Fasten both feet (3) with 3 screws each.

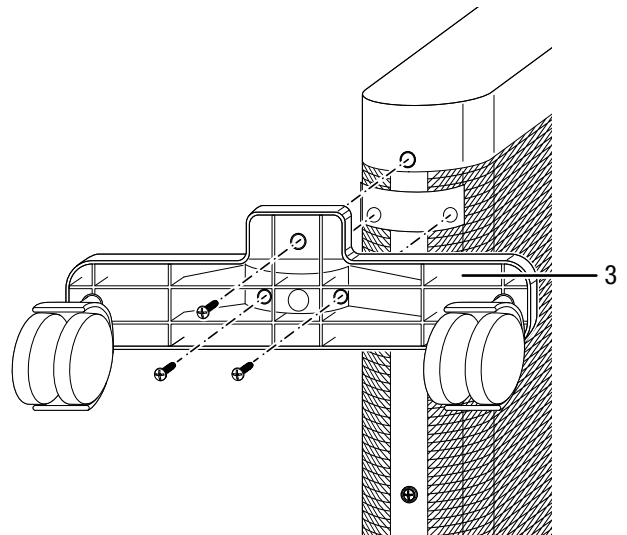

3. Check the feet (3) for tight fit.

4. Set the device up in an upright and stable position.

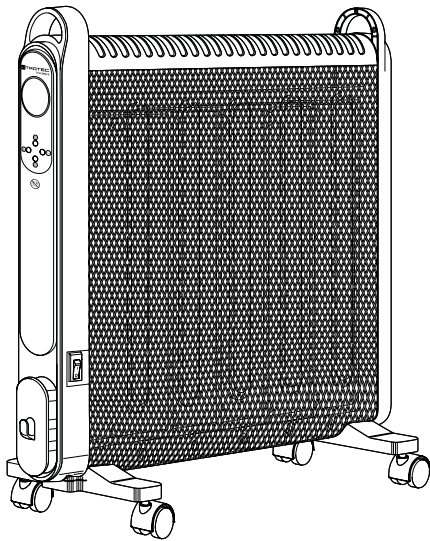

Start-up



Info

Odours might arise upon initial start-up or after a longer period of non-use.

When positioning the device, observe the minimum distance from walls or other objects as described in the chapter Technical annex.

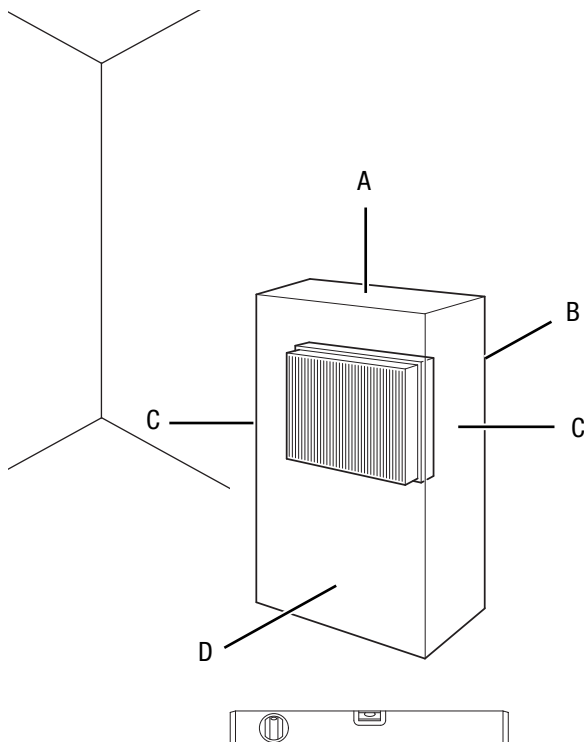

- Do not create tripping hazards when laying the power cable or other electric cables, especially when positioning the device in the middle of the room. Use cable bridges.
- Make sure that extension cables are completely unrolled.
- Make sure that no curtains or other objects interfere with the air flow.
- Do not position the device directly below a wall socket.
- Make sure that the device cannot come into contact with moisture or water.

Inserting batteries into the remote control



Warning of electrical voltage

Do not touch the battery compartment with wet or damp hands.

Note

Do not use rechargeable batteries!

Observe the Technical data for start-up.

1. Press the locking at the side of the battery compartment together and pull the battery compartment out of the remote control.
2. Insert a type CR 2025 battery into the battery compartment and slide the battery compartment back into the remote control.
 - ⇒ Make sure to insert the batteries into the battery compartment according to the correct polarity.

Connecting the power cable

- Insert the mains plug into a properly fused mains socket.
- Make sure that the power cable is guided along the back of the device. Never guide the power cable along the front of the device!

- Before restarting the device, check the condition of the power cable. If there are doubts as to the sound condition, contact the customer service.
- Set the device up in an upright and stable position.

Operation

- Avoid open doors and windows.

Control panel

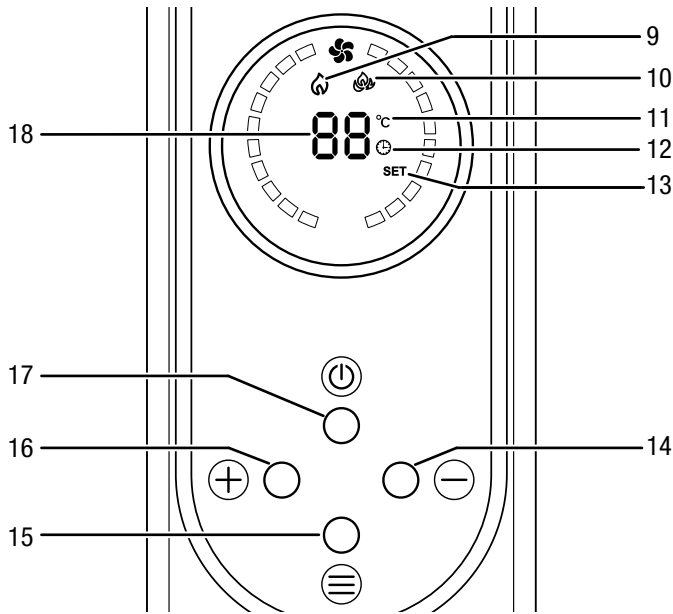

Remote control

All settings of the device can also be made using the remote control included in the scope of delivery.

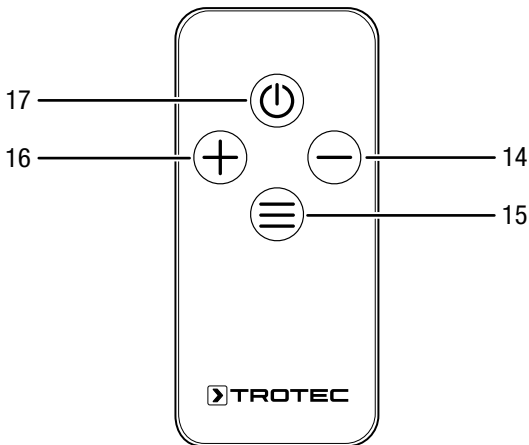

| No. | Designation | Meaning |
|-----|-------------------------|--|
| 9 | Low heating level icon | Low heating level activated (1200 W) |
| 10 | High heating level icon | High heating level activated (2000 W) |
| 11 | Temperature symbol | Illuminated when the desired or the current room temperature is indicated on the segment display |
| 12 | Timer icon | Flashes when the timer is activated. Illuminated during timer programming |
| 13 | SET indication | Illuminated during temperature setting or timer programming |

| No. | Designation | Meaning |
|-----|-----------------------|--|
| 14 | Decrease value button | For setting the desired room temperature (15 °C to 35 °C) or the number of hours for the timer (1 to 24 h) |
| 15 | MODE button | For timer programming For temperature setting |
| 16 | Increase value button | For setting the desired room temperature (15 °C to 35 °C) or the number of hours for the timer (1 to 24 h) |
| 17 | Power button | For activating the <i>low heating level</i> For activating the <i>high heating level</i> For activating standby mode |
| 18 | Segment display | Indication of the current room temperature during operation Indication of the desired room temperature during temperature adjustment Indication the number of hours during timer programming |



Warning

Fire hazard if device is covered or due to incorrect positioning of the device!
There is a risk of fire if the heating device is covered or incorrectly positioned.
Never cover the device during operation and position it with sufficient distance to walls and objects (according to the chapter Technical annex).

Switching the device on

Once you have completely installed the device as described in the chapter Assembly and start-up, you can switch it on.

1. Set the on/off switch (6) to **I**.
 - ⇒ An acoustic signal is emitted.
 - ⇒ The device is now in standby mode.
 - ⇒ The current room temperature is indicated on the segment display (18).
2. Press the *power* button (17).
 - ⇒ The device starts at the *low heating level*.
 - ⇒ The *low heating level* icon (9) is illuminated.



Info

In standby mode, the device memorizes the room temperature setting.

Setting the heating level

You can select the following heating levels:

- *low heating level* (heating capacity 1200 W)
 - *high heating level* (heating capacity 2000 W)
1. Press the *power* button (17) to set the *low heating level*.
⇒ The *low heating level* icon (9) will be displayed.
 2. Press the *power* button (17) again to set the *high heating level*.
⇒ The icon for the *high heating level* (10) will be indicated in addition to the icon for the *low heating level* (9).

Setting the desired room temperature

The room temperature determined by the temperature sensor is indicated on the *segment display* (18). You can set the desired room temperature at any time.

1. Repeatedly press the *MODE* button (15) until the *temperature* symbol (11) starts flashing.
⇒ The desired room temperature is displayed.
2. Press the buttons *increase value* (16) or *decrease value* (14) to adjust the desired room temperature. Setting is possible in the range between 15 °C and 35 °C in increments of 1 °C.
⇒ The desired room temperature is saved and indicated on the *segment display* (18) for approx. 5 seconds. Then the current room temperature is displayed again.



Info

The desired room temperature should be higher than the current room temperature.

Setting the timer

The timer has the following modes of operation:

- automatic switch-on upon expiry of a preset number of hours
- automatic switch-off upon expiry of a preset number of hours

The number of hours can be between 1 and 24 and can be adjusted in increments of 1 hour.

Note

The device must not be left unattended in a freely accessible room with an activated timer.

Automatic switch-on

- ✓ The device is switched on.
 - ✓ The device is in standby mode.
1. Press the *MODE* button (15).
⇒ The *timer* icon (12) flashes.
 2. Select the desired number of hours by use of the *increase value* (16) or *decrease value* (14) button.
⇒ The number of hours will be flashing on the *segment display* (18) for approx. 5 seconds.
⇒ The time until automatic switch-on is saved.
⇒ The *timer* icon (12) flashes.

Automatic switch-off

- ✓ The device is switched on.
 - ✓ The device runs at the set heating level.
1. Press the *MODE* button (15).
 2. Select the desired number of hours by use of the *increase value* (16) or *decrease value* (14) button. If you select 0 hours, the timer will be off.
⇒ The number of hours will be flashing on the *segment display* (18) for approx. 5 seconds.
⇒ The time until automatic switch-off is saved.
⇒ The *timer* icon (12) flashes.

Notes regarding automatic switch-off:

- Manually switching the device off disables the automatic switch-off function.
- If you select 0 hours, the timer will be off.

Shutdown



Warning of electrical voltage

Do not touch the mains plug with wet or damp hands.

1. Switch the device off by setting the on/off switch (6) to the **0** position.
2. Hold onto the mains plug while pulling the power cable out of the mains socket.
3. Allow the device to cool down sufficiently.
4. Clean the device according to the Maintenance chapter.
5. Store the device according to the Storage chapter.

Errors and faults



Warning of electrical voltage

Tasks which require the device to be opened must only be carried out by authorised specialist companies or by Trotec.

The device has been checked for proper functioning several times during production. If malfunctions occur nonetheless, check the device according to the following list.

The device does not start:

- Check the power connection.
- Check the power cable and mains plug for damage. If you notice damages, do not try to take the device back into operation.
If the supply cord is damaged, it must be replaced by the manufacturer, its service agent or similarly qualified persons in order to avoid a hazard.
- Check the on-site fusing.
- Check the room temperature. The room thermostat may have switched off, because the desired room temperature has been reached.
- The room thermostat might be defective. Have a defective room thermostat replaced by a specialist electrical company.

- Check whether the overheating protection has tripped (see chapter Safety).
- Wait for 10 minutes before restarting the device. If the device is not starting, have the electrics checked by a specialist company or by Trotec.

The device is switched on, but the heating is not operating:

- Check the room temperature. The room thermostat may have switched off, because the desired room temperature has been reached.
- Check whether the overheating protection has tripped (see chapter Safety).
- The heating resistor might have blown. Have a defective heating resistor replaced by a specialist electrical company.
- The room thermostat might be defective. Have a defective room thermostat replaced by a specialist electrical company.

The device does not respond to the infrared remote control:

- Check whether the distance between remote control and device is too large and reduce it if necessary.
- Make sure there are no obstacles, such as furniture or walls, between the device and the remote control. Ensure visual contact between device and remote control.
- Check the charging status of the batteries and change them if required.
- If the batteries have just been changed, check them for correct polarity.

Note

Wait for at least 3 minutes after maintenance and repair work. Only then switch the device back on.

The device still does not operate correctly after these checks:

Please contact the customer service. If necessary, bring the device to an authorised specialist electrical company or to Trotec for repair.

Maintenance

Activities required before starting maintenance



Warning of electrical voltage

Do not touch the mains plug with wet or damp hands.

- Switch the device off.
- Hold onto the mains plug while pulling the power cable out of the mains socket.
- Allow the device to cool down completely.



Warning of electrical voltage

Tasks which require the device to be opened must only be carried out by authorised specialist companies or by Trotec.

Cleaning the housing



Warning of electrical voltage

Never immerse the device in water!

Clean the housing with a soft, damp and lint-free cloth. Make sure that no moisture enters the housing. Protect electrical components from moisture. Do not use any aggressive cleaning agents such as cleaning sprays, solvents, alcohol-based or abrasive cleaners to dampen the cloth.

Wipe the housing dry after cleaning.

Technical annex

Technical data

| Parameter | Value |
|---|--|
| Model | TCH 2050 E |
| Heating capacity | 1200–2000 W |
| Operating range | -9 °C to 35 °C |
| Setting range | 15 °C to 35 °C |
| Mains connection | 230 V / 50–60 Hz |
| Power consumption, max. | 2000 W |
| Cable length | 1.2 m |
| Type of protection | IPX0 |
| Dimensions (depth x width x height) | 260 x 640 x 660 mm |
| Plug type | CEE 7/7 |
| Minimum distance to walls and other objects | A: top: 1 m B: rear: 1 m C: side: 1 m D: front: 1 m |
| Weight | 5 kg |
| Remote control batteries | Type CR 2025 |

Information requirements for electrical local space heaters

| Parameter | Value / item |
|--|---|
| Model | TCH 2050 E |
| Heat output | |
| Nominal heat output P_{nom} | 2.0 kW |
| Minimum heat output (indicative) P_{min} | 1.0 kW |
| Maximum continuous heat output $P_{max,c}$ | 2.0 kW |
| Auxiliary electricity consumption | |
| At nominal heat output $e_{l,max}$ | NA |
| At minimum heat output $e_{l,min}$ | NA |
| In standby mode $e_{l,sb}$ | 0.00162 |
| Type of heat input | |
| Manual heat charge control, with integrated thermostat | NO |
| Manual heat charge control with room and/or outdoor temperature feedback | NO |
| Electronic heat charge control with room and/or outdoor temperature feedback | NO |
| Fan assisted heat output | NO |
| Type of heat output/room temperature control | |
| Single-stage heat output, no room temperature control | NO |
| Two or more manual stages, no room temperature control | NO |
| With mechanic thermostat room temperature control | NO |
| With electronic room temperature control | NO |
| With electronic room temperature control plus day timer | YES |
| With electronic room temperature control plus week timer | NO |
| Other control options | |
| Room temperature control, with presence detection | NO |
| Room temperature control, with open window detection | NO |
| With distance control option | YES |
| With adaptive start control | NO |
| With working time limitation | NO |
| With black bulb sensor | NO |
| Contact details | Trotec GmbH Grebbeener Straße 7 D-52525 Heinsberg |

NA: not applicable

Disposal



The icon with the crossed-out waste bin on waste electrical or electronic equipment stipulates that this equipment must not be disposed of with the household waste at the end of its life. You will find collection points for free return of waste electrical and electronic equipment in your vicinity. The addresses can be obtained from your municipality or local administration. You can also find out about other return options that apply for many EU countries on the website <https://hub.trotec.com/?id=45090>. Otherwise, please contact an official recycling centre for electronic and electrical equipment authorised for your country.

The separate collection of waste electrical and electronic equipment aims to enable the re-use, recycling and other forms of recovery of waste equipment as well as to prevent negative effects for the environment and human health caused by the disposal of hazardous substances potentially contained in the equipment.



In the European Union, batteries and accumulators must not be treated as domestic waste, but must be disposed of professionally in accordance with Directive 2006/66/EC of the European Parliament and of the Council of 6 September 2006 on batteries and accumulators. Please dispose of batteries and accumulators according to the relevant legal requirements.

Only for United Kingdom

According to Waste Electrical and Electronic Equipment Regulations 2013 (2013/3113) and the Waste Batteries and Accumulators Regulations 2009 (2009/890), power tools that are no longer usable must be collected separately and disposed of in an environmentally friendly manner.

Trotec GmbH

Grebbener Str. 7
D-52525 Heinsberg

☎ +49 2452 962-400

☎ +49 2452 962-200

✉ info@trotec.com

www.trotec.com